

Influence of nozzle geometry on torch parameters during gas combustion

S. Khodjiev^{1*}, A. Pirimov², and A. X. Avezov¹

¹Bukhara State university, Bukhara, Uzbekistan

²Navoi State Mining and Innovations University, Navoi, Uzbekistan

Abstract. In this paper, when performing and analyzing the series of calculated results of the analysis of the sides of a rectangular nozzle for the parameters of a turbulent free air jet and a flame of a propane-butane mixture based on three-dimensional parabolic Navier-Stokes bonds for multicomponent reacting jets. To estimate the turbulent viscosity, differential equations of the kinetic and dissipation of the kinetic energy of turbulence are observed with refined empirical constants that are acceptable in turbulent combustion, as in the calculations, the initial values of the kinetic energy of turbulence did not exceed 5% of the dimensionless velocity of the main jet. It was found that when an air jet flows out of a nozzle with an aspect ratio of (1:2) and (1:4) in the initial sections of the jet, its shape behaves like an ellipse and, with the distance, it turns into a round one, with dimensionless, x greater or equal to 20 for the nozzle (1:2) and x greater or equal to 30 for (1:4), and for this variant there is again a transition to an elliptical shape. Studies of the diffusion combustion of a propane-butane mixture flowing out of a rectangular nozzle with an aspect ratio of (1:2) and (1:4) showed that with the ratio of the speed of the oxidizer to fuel m_{oi} , the flame length increases when m_{oi} between 0 and 0.164, and then, with an increase of m_{oi} more than 0.41, the torch length is shortened. The axial distributions of the momentum flux density with the aspect ratio (1:4), the jet core is shortened by 2÷2.5 times, compared with the aspect ratio (1:2) with the other parameters unchanged. Setting the tangential velocity at the mouth of the nozzle ($\omega=6.1$ m/s) leads to a decrease in the torch length by 11% compared to its value equal to zero.

1 Introduction

Although the reserves of natural combustible gas in the world are sufficient, they are limited, so scientists face a huge urgent problem of the need to develop a theoretical basis and practical applications in human activity for its effective use, as well as reducing the emission of harmful combustion products in the atmosphere. The combustion of natural gas, especially unmixed gases in turbulent flow, is widely used in various technical devices, such as combustion chambers, gas turbine engines, industrial furnaces, burners, etc.

To date, the combustion of natural gas has reached a high level of perfection, and a further increase in their efficiency is impossible without a thorough analysis of hydro-

*Corresponding author: s.hojiev@buxdu.uz

aerodynamic features and turbulence characteristics. However, the theory of turbulence and turbulent combustion has recently made significant progress.

Numerous classical works and monographs provide fundamental and applied developments in the theory of turbulence and combustion and the difficulties in these processes [1÷5].

The complexity of the problem under consideration is connected, on the one hand, with the incompleteness of the theory of turbulence, on the other hand, with the specific features of turbulent flows in the presence of chemical reactions, which consist in the extremely complex nature of the mutual influence of the processes of turbulent transfer and kinetics on the processes of heat and mass transfer.

Despite all the practical importance of the phenomenon of turbulent combustion and extensive experience in its application, there is still not only a quantitative theory of this phenomenon but even generally accepted fundamental ideas that could form the basis for such a theory.

Among various problems of applied gas dynamics of jet flows, studies of the propagation of jets flowing from a rectangular hole are of considerable interest. Such flows, which are often encountered in ventilation and furnace technology (slot burners, etc.), can be calculated using the usual semi-empirical theory of the boundary layer only in the limiting case of an infinitely long slot (flat jet), or at considerable distances from the beginning of the flow, where a jet of any initial shape turns into a round one.

The study of turbulent jets flowing from nozzles of rectangular cross sections has been carried out by various authors for about ninety years.

The first detailed experimental work, in which the fields of the average velocity behind a rectangular nozzle with the ratio of the sides of the initial cross-section of 1,2, 5,10, was carried out by Turku's [6], and various semi-empirical theories of a plane axisymmetric jet [7] and numerous experimental-numerical calculations were developed [7-14] concerning mainly flows of the jet type and behind the body.

In recent years, three-dimensional turbulent boundary layers and jet streams have become the subject of numerous experimental and computational-theoretical studies [14-19] mainly related to air.

A detailed numerical study of the parameters of a flame flowing from a nozzle of a rectangular or any complex shape is practically absent in publications, but there are some works devoted to spatial combustion [20-22]

At present, it becomes obvious that a direct natural experiment for studying three-dimensional turbulent, reacting jets (combustion) is long, expensive, and often dangerous due to the toxicity of gases, etc. Therefore, it becomes obvious that such high demands must be placed on mathematical models of such flows (processes), applications (methods), and their implementation on high-speed computer technologies, i.e., creating a triad "model - algorithm - program".

From the above brief review, it follows that the theory and methods for calculating turbulent jet homogeneous and reacting flows, particularly combustible mixtures, require further detailed development, which is explained by the extremely complex nature of combustion as a physical and chemical process.

2 Objects and methods of research

Formulation of the problem. A numerical study is required of a three-dimensional reacting combustible jet flowing out of a nozzle with a rectangular cross-section and propagating in a cocurrent air (oxidizer) flow during diffusion combustion.

Let us arrange the coordinate system in such a way that the origin of coordinates is located at the intersection of the diagonals of a rectangular nozzle with sides $2a$ and $2b$, the

Ox axis is directed along the main jet, and the Oy and Oz axes are parallel to the sides of the nozzle. Let us assume that the flow is centrally symmetric about the Ox axis so that it is sufficient to consider only one-quarter of the jet rectangle, and the two boundaries of the integration region are formed by symmetry planes.

The investigated three-dimensional flow can be modeled in physical coordinates in the form [23-26].

Continuity equation

$$\frac{\partial \rho u}{\partial x} + \frac{1}{L} \frac{\partial \rho u}{\partial y} + \frac{\partial \rho \omega}{\partial z} = 0. \quad (1)$$

$$\rho u \frac{\partial u}{\partial x} + \rho v \frac{\partial u}{L \partial y} + \rho \omega \frac{\partial u}{\partial z} = -\frac{\partial P}{\partial x} + \frac{1}{L^2} \frac{\partial}{\partial y} \left(\mu \frac{\partial u}{\partial y} \right) + \frac{\partial}{\partial z} \left(\mu \frac{\partial u}{\partial z} \right). \quad (2)$$

$$\rho u \frac{\partial v}{\partial x} + \rho v \frac{\partial v}{L \partial y} + \rho \omega \frac{\partial v}{\partial z} = -\frac{\partial P}{L \partial y} + \frac{4}{3L^2} \frac{\partial}{\partial y} \left(\mu \frac{\partial v}{\partial y} \right) + \frac{\partial}{\partial z} \left(\mu \frac{\partial v}{\partial z} \right) - \frac{2}{3L} \frac{\partial}{\partial y} \left(\mu \frac{\partial \omega}{\partial z} \right) + \frac{1}{L} \frac{\partial}{\partial z} \left(\mu \frac{\partial \omega}{\partial y} \right) \quad (3)$$

$$\rho u \frac{\partial \omega}{\partial x} + \rho v \frac{\partial \omega}{L \partial y} + \rho \omega \frac{\partial \omega}{\partial z} = -\frac{\partial P}{\partial z} + \frac{4}{3} \frac{\partial}{\partial z} \left(\mu \frac{\partial \omega}{\partial z} \right) + \frac{1}{L^2} \frac{\partial}{\partial y} \left(\mu \frac{\partial \omega}{\partial y} \right) + \frac{1}{L} \frac{\partial}{\partial y} \left(\mu \frac{\partial v}{\partial z} \right) - \frac{2}{3L} \frac{\partial}{\partial z} \left(\mu \frac{\partial v}{\partial y} \right) \quad (4)$$

Energy transfer equation (total enthalpy)

$$\rho u \frac{\partial H}{\partial x} + \rho v \frac{1}{L} \frac{\partial H}{\partial y} + \rho \omega \frac{\partial H}{\partial z} = \frac{1}{L^2} \frac{1}{Pr_T} \frac{\partial}{\partial y} \left(\mu \frac{\partial H}{\partial y} \right) + \frac{1}{Pr_T} \frac{\partial}{\partial z} \left(\mu \frac{\partial H}{\partial z} \right) + Q_{dis} \quad (5)$$

where

$$Q_{dis} = \left(1 - \frac{1}{Pr_T} \right) \left\{ \frac{1}{L^2} \frac{\partial}{\partial y} \left(\mu u \frac{\partial u}{\partial y} \right) + \frac{\partial}{\partial z} \left(\mu u \frac{\partial u}{\partial z} \right) + \frac{\partial}{\partial z} \left(\mu v \frac{\partial v}{\partial z} \right) + \frac{1}{L^2} \frac{\partial}{\partial y} \left(\mu \omega \frac{\partial \omega}{\partial y} \right) \right\} +$$

$$+ \left(\frac{4}{3} - \frac{1}{Pr_T} \right) \left\{ \frac{1}{L^2} \frac{\partial}{\partial y} \left(\mu v \frac{\partial v}{\partial y} \right) + \frac{\partial}{\partial z} \left(\mu \omega \frac{\partial \omega}{\partial z} \right) \right\} - \frac{1}{L} \frac{\partial}{\partial y} \left(\frac{2}{3} \mu \vartheta \frac{\partial \omega}{\partial z} \right) + \frac{1}{L} \frac{\partial}{\partial z} \left(\mu v \frac{\partial \omega}{\partial y} \right) + \frac{1}{L} \frac{\partial}{\partial y} \left(\mu \omega \frac{\partial \vartheta}{\partial z} \right) - \frac{1}{L} \frac{\partial}{\partial z} \left(\frac{2}{3} \mu \omega \frac{\partial \vartheta}{\partial y} \right).$$

$$\rho u \frac{\partial \bar{c}}{\partial x} + \rho \vartheta \frac{1}{L} \frac{\partial \bar{c}}{\partial y} + \rho \omega \frac{\partial \bar{c}}{\partial z} = \frac{1}{Sc_T} \frac{1}{L^2} \frac{\partial}{\partial y} \left(\mu \frac{\partial \bar{c}}{\partial y} \right) + \frac{1}{Sc_T} \frac{\partial}{\partial z} \left(\mu \frac{\partial \bar{c}}{\partial z} \right) \quad (6)$$

$$P = \rho T \sum_{i=1}^{N_K} \frac{C_i}{m_i} \quad (7)$$

$$H = C_p T + \frac{u^2 + v^2 + \omega^2}{2} + \sum_{i=1}^{N_K} C_i h_i^* \quad (8)$$

$$\rho u \frac{\partial k}{\partial x} + \rho v \frac{\partial k}{L \partial y} + \rho \omega \frac{\partial k}{\partial z} = \frac{1}{L^2} \frac{\partial}{\partial y} \left(\mu_T \frac{\partial k}{\partial y} \right) + \frac{\partial}{\partial z} \left(\mu_T \frac{\partial k}{\partial z} \right) + G - \rho \varepsilon. \quad (9)$$

$$\rho u \frac{\partial \varepsilon}{\partial x} + \rho v \frac{\partial \varepsilon}{L \partial y} + \rho \omega \frac{\partial \varepsilon}{\partial z} = \frac{1}{L^2} \frac{\partial}{\partial y} \left(\mu_T \frac{\partial \varepsilon}{\partial y} \right) + \frac{\partial}{\partial z} \left(\mu_T \frac{\partial \varepsilon}{\partial z} \right) + (C_1 G - C_2 \rho \varepsilon) \frac{\varepsilon}{k} \quad (10)$$

$$G = \mu_T \left[\left(\frac{\partial u}{L \partial y} \right)^2 + \left(\frac{\partial u}{\partial z} \right)^2 \right], \quad \mu_T = \frac{C_\mu \rho k^2}{\varepsilon} \quad (11)$$

In these equations $\sigma_k, \sigma_\varepsilon, C_1, C_2, C_\mu$ are empirical constants.

The system of equations (1-11) is reduced to a dimensionless form by choosing as scales for length, velocity, temperature, total enthalpy, pressure, molecular weight, density, viscosity, heat capacity, heat of formation of the i -th component, kinetic energy of turbulence and its dissipations, respectively, b (length along the OZ axis), $u_2, u_2^2/(R/m_1), u_2^2, \rho_2 u_2^2, m_1, \rho_2, \rho_2 u_2 b, R/m_1, u_2^2, u_2^2, u_2^2/b$, and also for the convenience of the numerical solution, mathematical transformations were carried out, which made it possible to bring the inlet section of the nozzle into a square one using $y = \bar{y}/\bar{L}$ (the $\bar{L} = a/b$).

The concentration equation (6) for problems of diffusion combustion is written using the conservative Schwab-Zel'dovich function [3,25,26] relative to the excess concentration

\bar{C} which allows you to get rid of the source term in the concentration equation for a four-component mixture and reduces the number of equations to one, i.e., in the form (6), and \bar{C} takes the value equal to 1 at the outlet of the fuel channel and 0 in the oxidizer zone.

Boundary and initial conditions. The dimensionless system of equations (1÷11) of the previously made assumptions is solved using the following dimensionless initial and boundary conditions:

I.x=0:

$$1. 0 \leq y \leq 1, 0 \leq z \leq 1: u=1, v=0, \omega = 0, H = H_2, P = P_2, \bar{C} = 1, k = k_2, \varepsilon = \varepsilon_2. \quad (12)$$

$$2. 1 < y < y_{+\infty}, 1 < z < z_{+\infty}: u=u_1, v=0, \omega = 0, H = H_1, P = P_1, k = k_1, \varepsilon = \varepsilon_1.$$

II.x>0;

$$1. z=0, 0 < y < y_{+\infty}: \frac{\partial u}{\partial z} = 0, \frac{\partial v}{\partial z} = 0, \omega = 0, \frac{\partial H}{\partial z} = 0, \frac{\partial \bar{C}}{\partial z} = 0, \frac{\partial k}{\partial z} = 0, \frac{\partial \varepsilon}{\partial z} = 0$$

$$2. y=0, 0 < z < z_{+\infty}: \frac{\partial u}{\partial y} = 0, v = 0, \frac{\partial \omega}{\partial y} = 0, \frac{\partial H}{\partial y} = 0, \frac{\partial \bar{C}}{\partial y} = 0, \frac{\partial k}{\partial y} = 0, \frac{\partial \varepsilon}{\partial y} = 0. \quad (13)$$

$$3. z=0, y = 0: \frac{\partial u}{\partial y} = \frac{\partial u}{\partial z} = \frac{\partial H}{\partial y} = \frac{\partial H}{\partial z} = v = \omega = 0, \frac{\partial k}{\partial y} = \frac{\partial k}{\partial z} = \frac{\partial \varepsilon}{\partial y} = \frac{\partial \varepsilon}{\partial z} = 0.$$

$$4. z \rightarrow z_{+\infty}, y \rightarrow y_{+\infty}, u = u_1, v = 0, \omega = 0, H = H_1, P = P_1, \bar{C} = 0, k = k_1, \varepsilon = \varepsilon_1.$$

On a scale and boundary conditions, the subscripts correspond to the parameters of the oxidizer jet 1 and the fuel index 2.

Solution method. Based on the method of solving a system of equations (1÷11) with boundary conditions (12-13), the most common solution strategy proposed by Patankar and Spalding [24] and implemented in the SIMPLE procedure (Semi-Implicit Method for Pressure – Linked Equations) and its modifications [25].

For the numerical integration of the system, a spatial two-layer ten-point finite-spaced scheme was used, and the method of the cyclic sequence of operations "assumption - correction" was applied.

In the system of equations (1÷11) are partially parabolized; therefore, their elliptic effects appear through the pressure field [24], and their elliptical properties associated with the pressure field are preserved. The latter requires that the solution, which is obtained by successively passing from one section to another in the longitudinal direction, would be refined by iteration.

We can briefly describe the algorithm of the calculation method as follows. Using some initial pressure field and other initial parameters of the fuel and oxidizer at the nozzle outlet, we first calculate the velocity components using the equations of motion. The pressure and velocity components are then adjusted to satisfy the continuity equation. To find the correct pressure distribution, we use the equations of motion and continuity.

Sequentially solving systems of equations using finite-difference methods using scalar sweep in the yOz plane, we find preliminary solutions u, v, ω . True solutions u, v, ω , and P will be expressed respectively as the found preliminary plus correction.

As in Patankar and Spaulding's original approach, it is assumed that the pressure corrections determine the velocity corrections according to very approximate equations of motion in which the longitudinal convective terms are balanced by the pressure terms but with three equations of motion having the form

$$\rho u \frac{\partial u_c}{\partial x} = - \frac{\partial P_c}{\partial x}, \quad \rho u \frac{\partial v_c}{\partial x} = - \frac{\partial P_c}{L \partial y}, \quad \rho u \frac{\partial \omega_c}{\partial x} = - \frac{\partial P_c}{\partial z}, \quad (14)$$

here the index c refers to the correction parameters, and P_c is simply some potential function that is used to generate speed corrections that satisfy the continuity equation.

3 Numerical results

In the following, we present some numerical results of studying the influence of the aspect ratio of the nozzle on the parameters of the gas jet and on the parameters of the diffusion flame, the outflow of a propane-butane gas mixture from a rectangular nozzle based on the system of equations (1 ÷ 11) with boundary conditions (12÷13) according to the above method and in detail the algorithm described in [25].

The first methodological study considers the outflow of a free air jet from a rectangular nozzle borrowed from [12], with a side length ratio of 1:2. On fig. Figures 1 and 2 compare the results of calculations with the experimental data of works [12] on the distribution of the momentum flux density in the jet cross section at $x=60$ mm, as well as its changes along the jet axis. It was assumed that the aspect ratio (a:b)=15×30 mm, the speed of the main flow of the jet $u_2=38$ m/s, and the satellite flow $u_1=0$, as well as $P_1=P_2=1$ atm, $T_1=T_2=300$ K and Prandtl number =0.65.

It can be seen from the graphs that when choosing the empirical constants " $\kappa - \varepsilon$ " in the turbulence model, it is possible to obtain satisfactory agreement with experimental data [12]. Fig.3 and Fig.4 show visual images of the expansion of the jet boundary at the nozzle aspect ratio (1:2) and (1:4). From the expansion of the boundary zone for a rectangular nozzle of the output section with an aspect ratio (1:2), shown in Fig.3, it can be seen that in the initial sections, the shape of the jet behaves like an ellipse and, and then with a distance from the nozzle section. at $\bar{x} \geq 20$, it turns into a round shape, which is preserved with distance from the nozzle cutoff. Numerical results have shown that in the initial regions of the jet, a similar pattern is observed at the nozzle aspect ratio (1:4), but the transition to a round one begins at $\bar{x} \geq 30$. The most interesting thing is that in this variant, the transition to an ellipsoid shape occurs again after the transition to a round shape. This behavior of jet propagation was observed in the experiments of [8]. Numerical results confirmed the experimental data [12-14] related to the propagation of a three-dimensional jet that the intensity of the increase in the thickness of the boundary layer in the OXY and OXZ planes is different.

Based on the method of the equivalent problem of the theory of heat conduction, the calculation of a turbulent diffusion plume, outflow from a rectangular nozzle, can give satisfactory results, apparently, only in the far region of the jet, where the motion is close to axisymmetric [20].

The parameters of the combustible jet and the oxidizer at the nozzle exit were set to uniform and stepped values, and the pressures were equal to each other. Numerical studies were carried out based on a model of diffusion combustion of a propane-butane mixture in the air with the following initial data:

<p>I. Fuel zone:</p> <p>$T_2 = 300\text{K}; u_2 = 61 \text{ m/c};$</p> <p>$(c_1)_2 = 0; (c_2)_2 = 0,12;$</p> <p>$(c_3)_2 = 0; (c_4)_2 = 0,88;$</p> <p>$k_2 = \beta_2 u_2^2; \varepsilon_2 = \gamma_2 k_2^{3/2};$</p>	<p>II. Oxidizer zone:</p> <p>$u_2 = 0 (5,10,18,25 \text{ m/c}); T_1 = 300\text{K};$</p> <p>$(c_1)_1 = 0,232; (c_2)_1 = 0; (c_3)_1 = 0;$</p> <p>$(c_4)_1 = 0,768;$</p> <p>$k_1 = \beta_1 u_1^2; \varepsilon_1 = \gamma_1 k_1^{3/2};$</p>
--	---

$$P_1 = P_2 = P_{atm} = 1_{atm}, Pr_T = Sc_T = 0.7.$$

For the numerical study, rectangular nozzles with side sizes (15mm × 30mm) and (15mm × 60mm) were selected, which makes the aspect ratios (1:2) and (1:4) [12].

Several numerical results concerning the study of the influence of the ratio of the sides of a rectangular nozzle and jet entanglement (parameter m_u), as well as input conditions on the parameters of diffusion combustion, are shown in the form of graphs in Figures (5÷8).

In particular, figures (5÷6) show the results related to a rectangular nozzle with an aspect ratio of (a:b) = (15mm:30mm) = (1:2), with a wide change in the co-occurrence parameter m_u .

With the help of numerical studies, it was found that for a nozzle with an aspect ratio (1:2), with small parameters of co-occurrence ($m_u=0$; $m_u=0.082$), the width of the temperature shift zone is wider than at large m_u the emission does not significantly affect the maximum fan temperature. All the above results were obtained at initial transverse velocities $\vartheta=0$ and $\omega=0$, respectively.

Figures 7 and 8 show the configurations of the submerged diffusion flame and the axial distribution of the momentum flux density in the case of the nozzle aspect ratio (a:b)=(1:4) and under different input conditions of the tangential velocity ω , with the same initial values of the other parameters of the jet and the oxidizer. From the configuration of the diffusion flame, shown in Fig. 6, it can be seen that the given tangential nozzle velocity $|\omega_2|_{x=0} = 6.1$ m/s leads to a decrease in the length of the flame compared to its value equal to zero.

From the axial distributions of the momentum flux density (Fig. 8) with the aspect ratio (1:4), it can be seen that the jet core is shortened by 2–2.5 times compared with the aspect ratio (1:2), with the initial data of other unchanged parameters. This can be explained by the involvement of a large mass of cocurrent due to suction, i.e., the appearance of a transverse velocity, which leads to attenuation when the jet propagates faster than the aspect ratio of the nozzle (1:2).

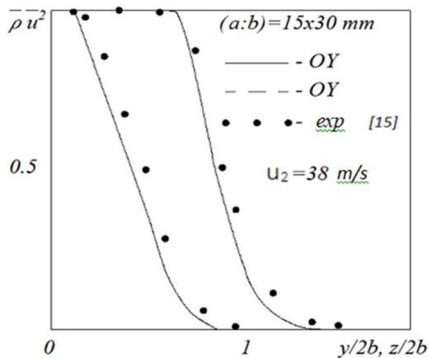

Fig. 1. Comparison of calculated and experimental data on momentum flux density distribution at $x = 60$ mm

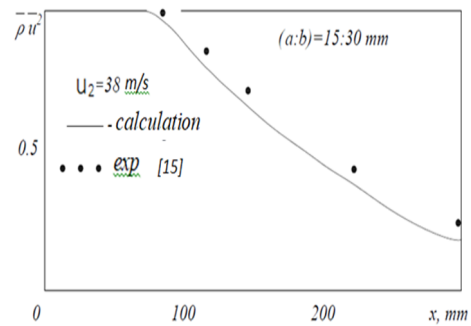

Fig. 2. Comparison of calculated and experimental data on momentum flux density distribution along the jet axis.

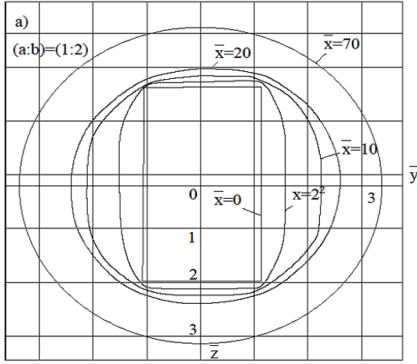

Fig. 3. The boundaries of the jet propagation at an aspect ratio (1:2).

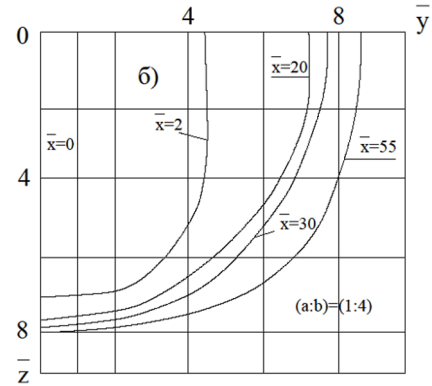

Fig. 4. The boundaries of the jet propagation at an aspect ratio (1:4).

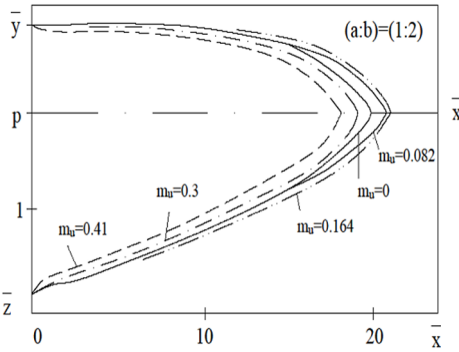

Fig. 5. Torch configuration in different mode parameters m_u at aspect ratio (1:2)

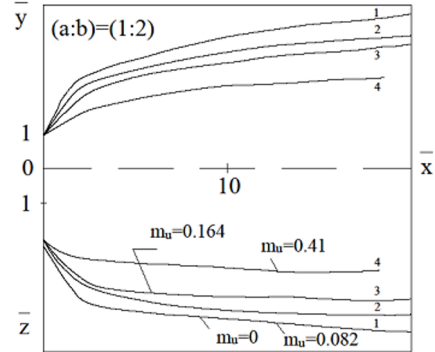

Fig. 6. Dependences of the increase in the thickness of the mixing zone in different values of the mode parameter m_u at aspect ratio (1:2).

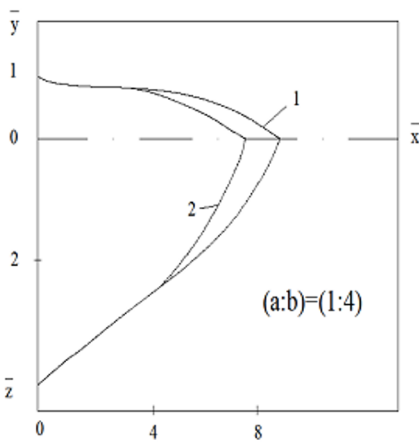

Fig.7. Torch configuration with nozzle aspect ratio (1:4): 1 - $\omega_2/x=0=0$; 2 - $\omega_2/x=0=6.1\text{ m/s}$.

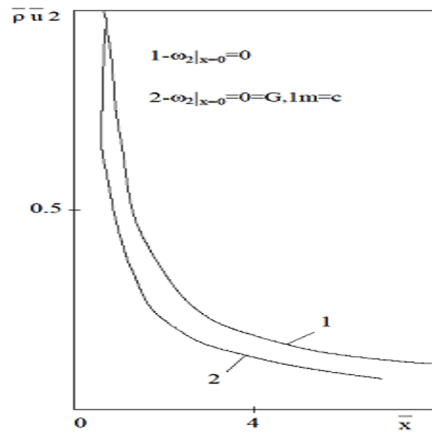

Fig. 8. Distribution of the pulse flux density at the nozzle aspect ratio (1:4).

4 Conclusions

It has been established that with the aspect ratio (1:1), the shape of the torch takes on the greatest length, and with the aspect ratio (1:2) and (1:4), the length of the torch is shortened;

- it was found that an increase in the initial value of the co-flow velocity within $m_u = u_1/u_2 \leq 0.164$ lengthens the shape of the torch, and at high values, it leads to a shortening of the shape and narrowing of the jet displacement area;

- it has been numerically obtained that with the ratio of the sides of the nozzle (1:2) in the initial sections, the shape of the jet behaves like an ellipse and, with distance from the nozzle exit, turns into a round shape, which is preserved, and with an aspect ratio (1:4) the transition to the round shape is tightened and turns into a round one, and then turning into an ellipse shape again turns into a round shape.

References

1. Abramovich G. N., Girshovich T. A., Krasheninnikov S. I., Sekundov, A. N., and Smirnova I. P. The theory of turbulent jets. Moscow Izdatel Nauka. (1984).
2. Abramovich G. N. On the deformation of the rectangular turbulent jet cross-section. International Journal of Heat and Mass Transfer, Vol. 25(12), pp.1885-1894. (1982).
3. Zel'dovich Ya. B. K teorii goreniiya neperemeshannykh gazov. Zhurnal tekhnicheskoy fiziki, Vol. 19(10), p.1199. (1949).
4. Xodjiev S., Yuldoshev S. H., and Savriev S. H. To the calculation of a model of a three-dimensional turbulent diffusion plane. Science and Innovation, Vol. 1(8), pp. 1211-1219. (2022).
5. Kuznetsov V. R., Sabel'Nikov V. A. E., and Libby P. A. Turbulence and combustion Vol. 8. New York: Hemisphere. (1990).
6. Chawdhury M. A., and Mahkamov K. Development of a small downdraft biomass gasifier for developing countries. Journal of scientific research, Vol. 3(1), p.51. (2011).
7. Faghani E., Maddahian R., Faghani P., and Farhanieh B. Numerical investigation of turbulent free jet flows issuing from rectangular nozzles: the influence of small aspect ratio. Archive of applied mechanics, Vol. 80(7), pp. 727-745. (2010).
8. Steiger M. H., and Bloom M. H. Three-dimensional effects in viscous wakes. AIAA Journal, Vol. 1(4), pp. 776-782. (1963).
9. Kuo Y. H., and Baldwin L. V. Comments on three-dimensional effects in viscous wakes. AIAA Journal, Vol. 2(6), pp.1163-1164. (1964).
10. Borue V., and Orszag S. A. Local energy flux and subgrid-scale statistics in three-dimensional turbulence. Journal of Fluid Mechanics, Vol. 366, pp.1-31. (1998).
11. Oberleithner K., Sieber M., Nayeri C. N., Paschereit C. O., Petz C., Hege H. C., and Wygnanski I. Three-dimensional coherent structures in a swirling jet undergoing vortex breakdown: stability analysis and empirical mode construction. Journal of fluid mechanics, Vol. 679, pp. 383-414. (2011).
12. Deo R. C., Nathan G. J., and Mi J. Comparison of turbulent jets issuing from rectangular nozzles with and without sidewalls. Experimental Thermal and Fluid Science, Vol.32(2), pp. 596-606. (2007).
13. Gojon R., Baier, F., Gutmark E. J., and Mihaescu M. Temperature effects on the aerodynamic and acoustic fields of a rectangular supersonic jet. In 55th AIAA aerospace sciences meeting, p. 0002. (2017).

14. Sforza P. M., Steiger M. H., and Trentacoste N. Studies on three-dimensional viscous jets. *AIAA journal*, Vol. 4(5), pp.800-806. (1966).
15. Lozanova M., and Stankov P. Experimental investigation on the similarity of a 3D rectangular turbulent jet. *Experiments in Fluids*, Vol. 24(5-6), pp.470-478. (1998).
16. Hjertager, B. H., and Magnussen, B. F. Calculation of turbulent three-dimensional jet induced flow in rectangular enclosures. *Computers and Fluids*, Vol.9(4), pp. 395-407. (1981).
17. McGuirk J. J., and Rodi W. The calculation of three-dimensional turbulent free jets. In *Turbulent Shear Flows I: Selected Papers from the First International Symposium on Turbulent Shear Flows*, The Pennsylvania State University, University Park, Pennsylvania, USA, (pp. 71-83). Springer Berlin Heidelberg. (1979).
18. Agulykov A., Dzhaugashtin K. E., and Iarin L. P. Investigation of the structure of three-dimensional turbulent jets. *Akademiia Nauk SSSR Izvestiia Mekhanika Zhidkosti i Gaza*, Vol. 10, pp.13-21. (1975).
19. Eichelbrenner, E. A. Three-dimensional boundary layers. *Annual Review of Fluid Mechanics*, Vol. 5(1), pp.339-360. (1973).
20. Marov M. Y., and Kolesnichenko A. V. Turbulent Motion of Multicomponent Mixtures with Variable Thermophysical Properties. *Mechanics of Turbulence of Multicomponent Gases*, pp. 112-165. (2001).
21. Markatos N. C. G. The computation of steady and unsteady turbulent, chemically reacting flows in axi-symmetrical domains. (1979).
22. Carpenter M. Three-dimensional computations of cross-flow injection and combustion in a supersonic flow. In *20th Fluid Dynamics, Plasma Dynamics and Lasers Conference*, p. 1870. (1989).
23. Oran E. S., Boris J. P., and Boris J. P. *Numerical simulation of reactive flow*, Vol. 2, Cambridge: Cambridge university press. (2001).
24. Magyari E., and Keller B. Heat and mass transfer in the boundary layers on an exponentially stretching continuous surface. *Journal of Physics D: Applied Physics*, Vol. 32(5), p.577. (1999).
25. Yuldoshev S., Savriev S., Murtazoyev A., and Khojiev S. Numerical simulation of three-dimensional turbulent jets of reacting gases. *Eurasian Journal of Mathematical Theory and Computer Sciences*, Vol. 2(6), pp.73-82. (2022).
26. Hamdamov M., Khujaev I., Bazarov O., and Isabaev K. Axisymmetric turbulent methane jet propagation in a wake air flow under combustion at a finite velocity. In *IOP Conference Series: Materials Science and Engineering*, Vol. 1030(1), p. 012163. (2021).